





Game Begins Now

【 kullanım kılavuzu 】

## Kutu İçeriği

 x16	 x6	 x8
Anakart Vidası	PSU Vidası	HDD vidası
 x3	 x5	
Bakır Anakart Vidası	Kablo Keleççeleri	

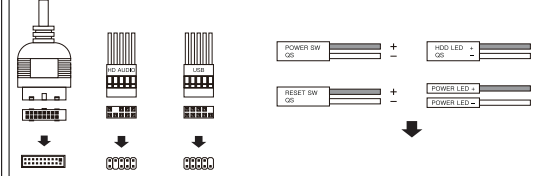

Herhangi bir özel bağlantı talimatı için lütfen anakartınızla birlikte gelen kılavuza bakın.

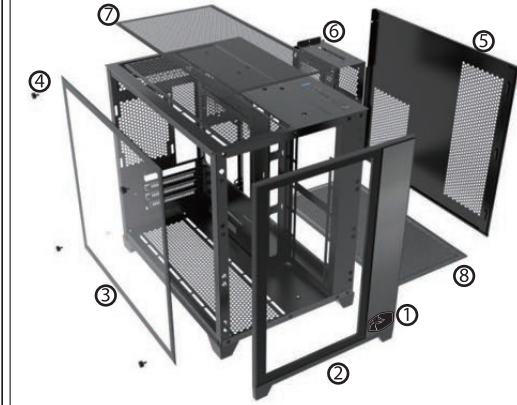

- ① Ön Panel
- ② Temperli Cam Ön Panel
- ③ Temperli Cam Yan Panel
- ④ Yan Panel Sabitleme Vidaları
- ⑤ Havalandırma Delikli Sac Yan Panel
- ⑥ HDD Yuvası
- ⑦ Üst Panel Toz Filtresi
- ⑧ Alt Panel Toz Filtresi

## Fan Kurulumu



1. Yan Panelleri Sökün
2. Fanları Monte Edin  
Üst: 12cmx3 (opsiyonel)  
Alt: 12cmx3  
Yan: 12cmx2  
Arka: 12cmx1
3. Hava Akış Diagramı

## HDD/SDD Kurulumu



1. HDD Yuvasının 3 adet vidalarını sökün.



2. SDD'yi Yuvanın dışına (üstüne) monte edin.



3. 2 Adet HDD'yi Yuvanın içine monte edin.

## PSU Kurulumu



1. Sağ Yan Paneli Açın.



2. PSU'yu Kasanın İçine Yerleştirin.



3. PSU'yu Vidalarıyla Sabitleyin

## USB 3.0 Kurulumu



1. USB 3.0 Mavi Kablo.



2. Insert into MB USB 3.0 port



3. USB 3.0 port on front panel

1. USB 3.0 Mavi Kablo.

2. Anakartın Üzerindeki USB 3.0 Portuna Takın.

3. Ön Paneldeki USB 3.0 Portu